



GEC0: A collection of solvers for the self-gravitating Vlasov equations

Ellery Ames ^{1*} and Anders Logg ^{2*}

1 Flax and Teal 2 Chalmers University of Technology * These authors contributed equally.

DOI: [10.21105/joss.05979](https://doi.org/10.21105/joss.05979)

Software

- [Review](#) 
- [Repository](#) 
- [Archive](#) 

Editor: [Dan Foreman-Mackey](#) 

Reviewers:

- [@michellegurevich](#)
- [@pmocz](#)

Submitted: 20 September 2023

Published: 11 December 2023

License

Authors of papers retain copyright and release the work under a Creative Commons Attribution 4.0 International License ([CC BY 4.0](#)).

Summary

Gothenburgh Einstein solver Collection (GEC0) is a collection of solvers for stationary self-gravitating collisionless kinetic (Vlasov) matter. The gravitational interaction may be taken to be either Newtonian or general relativistic. GEC0 is focused on the solutions which are axisymmetric, meaning that the gravitational and matter fields have a rotational symmetry. In this setting stationary solutions may be generated with the choice of a particular ansatz function for the Vlasov distribution function. GEC0 allows users to easily introduce new ansatz functions and explore the properties of the resulting stationary solutions.

Statement of need

In understanding a physical model one usually starts with a simplified setting, such as by imposing symmetry assumptions. In the case of self-gravitating kinetic matter, stationary solutions in the spherically symmetric setting are well understood ([Andréasson, 2011](#); [Binney & Tremaine, 2008](#)). However, many of the physical systems of interest such as accretion disks, galaxies, galaxy clusters and so on, require models beyond spherical symmetry. When going beyond spherical symmetry, the coupled and nonlinear PDE systems in high dimensions – such as the self-gravitating Vlasov equations – are difficult to investigate analytically, and numerical approaches are essential to understand behavior of solutions and to answer questions of physical and mathematical interest. The GEC0 code started with the desire to understand properties of stationary and axisymmetric solutions of the Einstein-Vlasov system.

Method and implementation

To construct stationary solutions, the code relies on a reduction method in which the distribution function for the matter is assumed to depend on the position and momentum phase-space coordinates solely through conserved quantities, such as the particle energy and angular momentum about the axis of symmetry. With this ansatz the Einstein–Vlasov or Vlasov–Poisson system (depending on the gravitational model used) forms a semi-linear integro-differential system of equations. In GEC0, the form of the ansatz is called a `MaterialModel` and several different choices are implemented as subclasses of the `FEniCS/DOLFIN Expression` class. The semi-linear integro-differential system is solved via a mass-preserving fixed point scheme using Anderson acceleration ([Walker & Ni, 2011](#)). At each step of the fixed point method, the linear system of equations is solved using finite elements implemented with the FEniCS toolkit ([Logg et al., 2012](#)). The computational domain is taken to be the half-meridional plane $\{(r, z) : r > 0, z > 0\}$ in cylindrical coordinates, with a semi-circular outer boundary; see [Figure 1](#). Details of the mathematical formulation and implementation can be found in ([Ames et al., 2016](#))

Functionality

The entrypoint for GECo is a run script written in Python. In this file, the user selects the solver class (`EinsteinVlasovSolver` or `VlasovPoisson`) that specifies the model for the gravitational interaction, a `MaterialModel` to specify the particular form of the reduction ansatz, and several parameters related to the model and discretization. Calling the `solve` method within the script invokes the solver to construct a stationary solution via the fixed point scheme mentioned above, which runs until convergence within a specified tolerance. Gravitational fields and matter quantities are saved in X MDF and XML format that can be consumed by visualization software like Paraview and VisIT, as well as postprocessing scripts. Multi-component solutions may be constructed from multiple `MaterialModels` by combining models in a weighted sum.

GECo includes several postprocessing routines that:

- generate additional scalar data not computed during the fixed point iteration;
- represent the matter density as well as an ergoregion (if present) in \mathbb{R}^2 (i.e. reflected about the reflection plane and symmetry axis), as shown in [Figure 2](#);
- represent the matter density as well as an ergoregion (if present) as a volume in \mathbb{R}^3 , facilitating visualization of contours, as shown in [Figure 3](#);
- represent the density as a three-dimensional point cloud, as shown in [Figure 4](#);
- compute the Kretschmann curvature scalar.

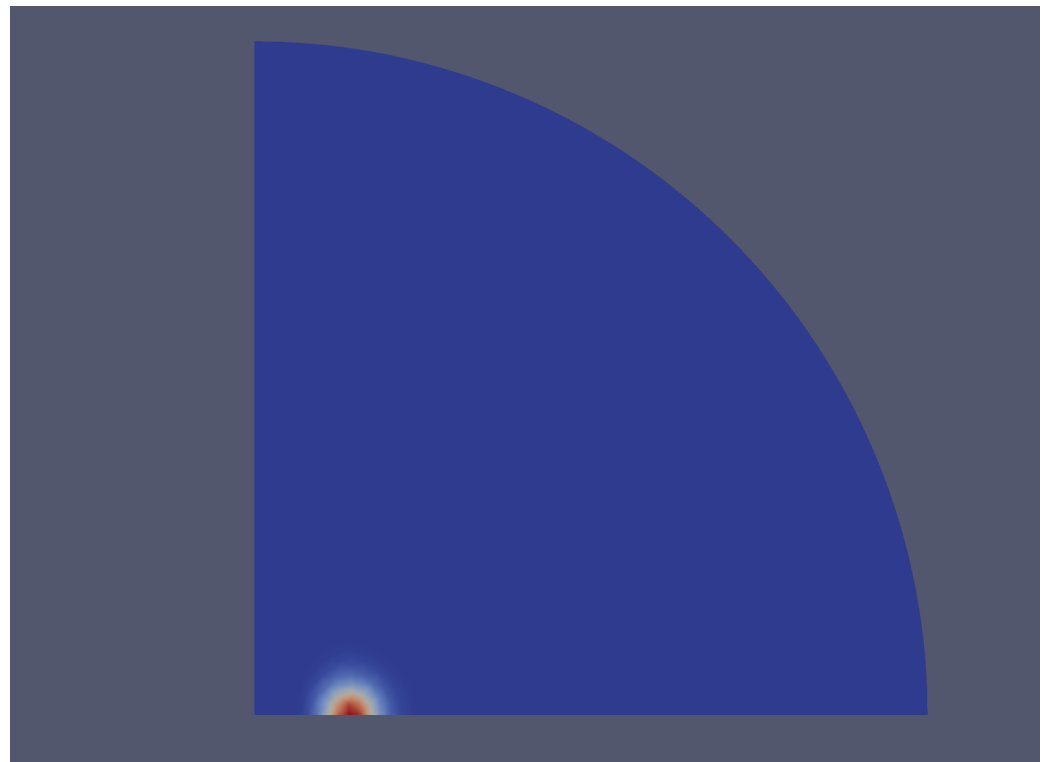

Figure 1: Computed spatial density of torus solution on the quarter plane computational domain.

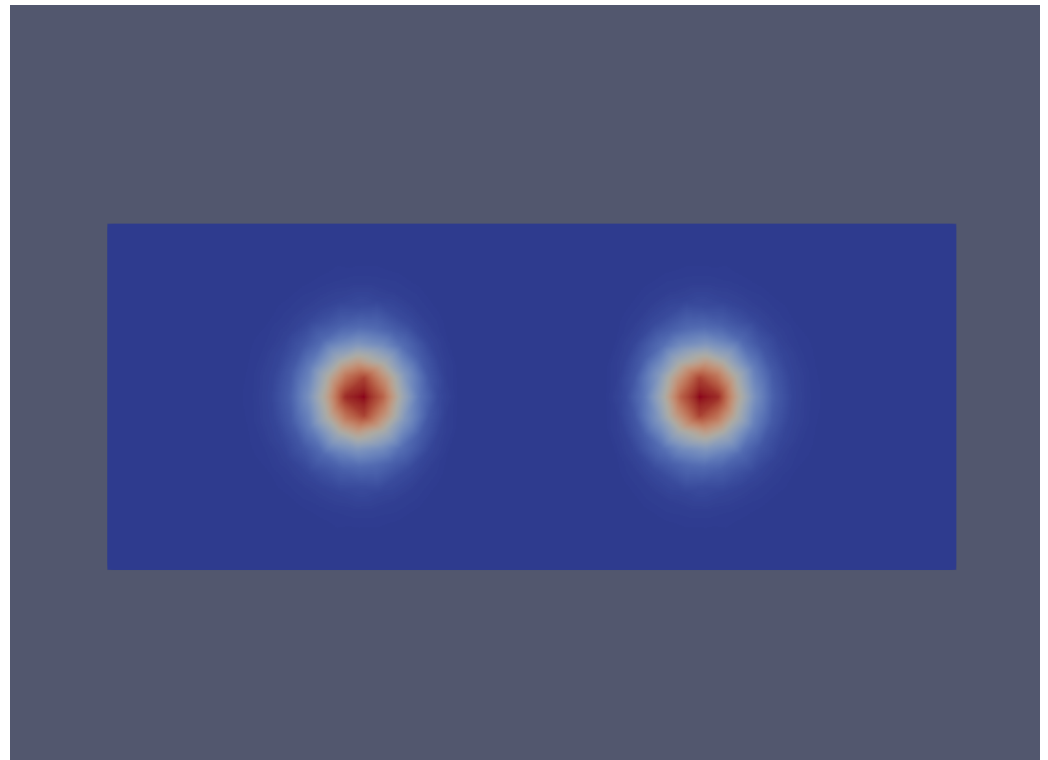

Figure 2: Computed spatial density of torus solution extended to xy -plane.

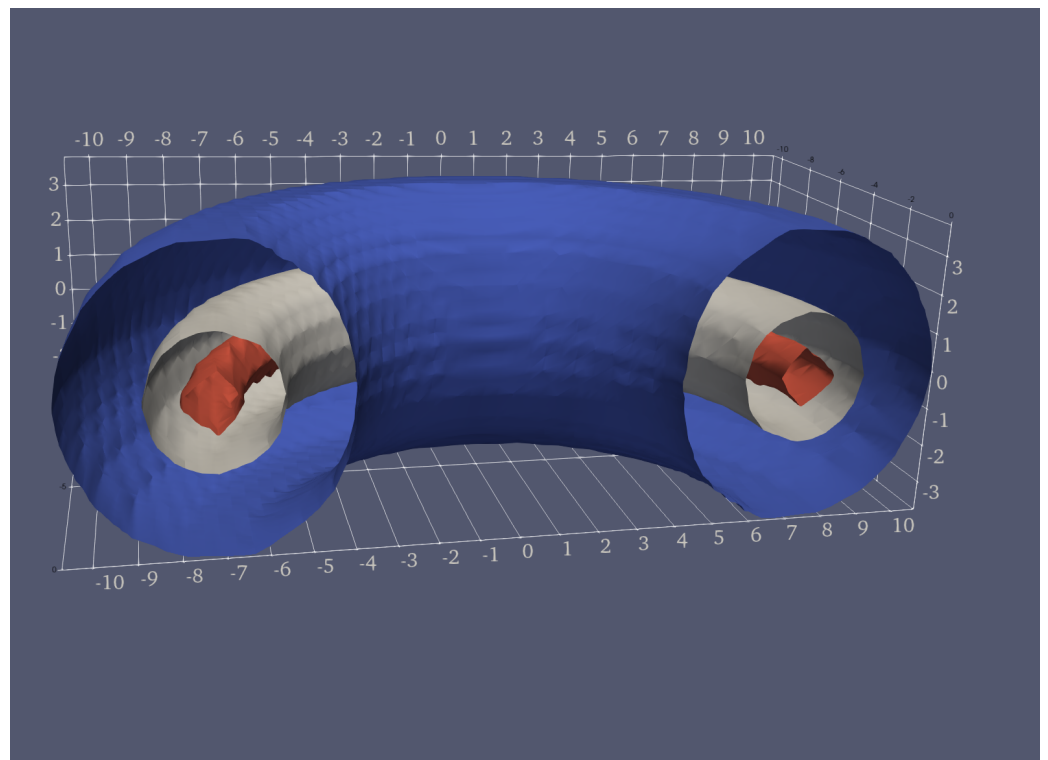

Figure 3: Computed spatial density of torus solution visualized as iso surfaces in 3D.

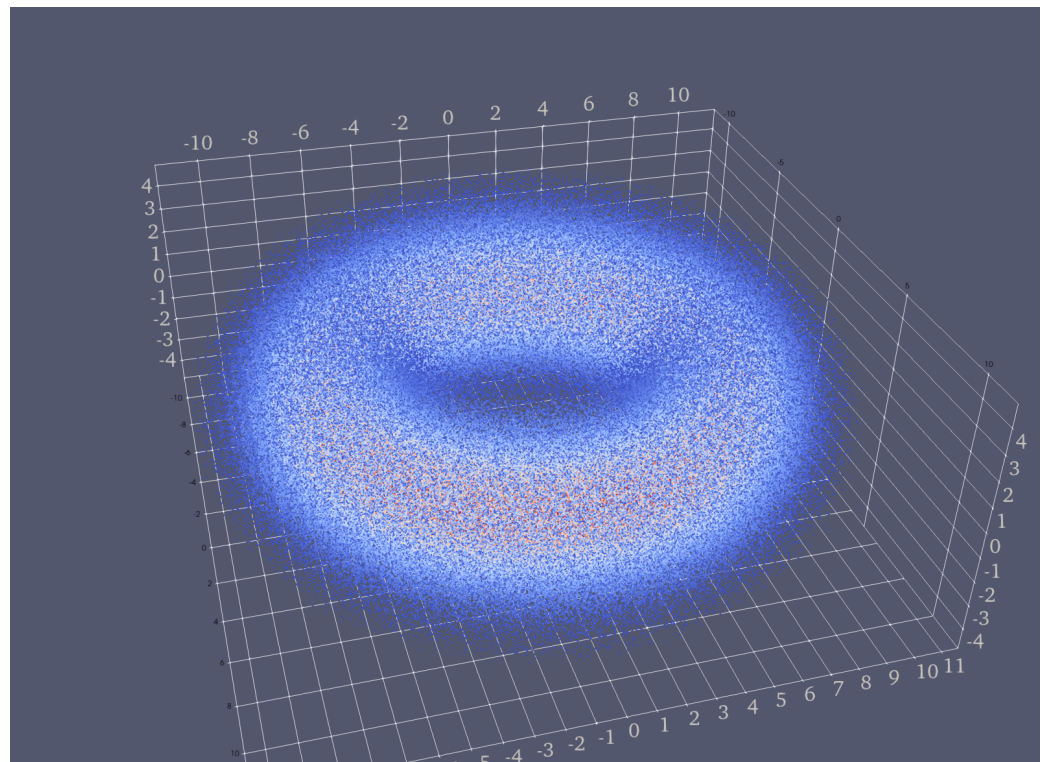

Figure 4: Computed spatial density of torus solution visualized as a point cloud.

Documentation

The documentation for GECo is published on the [GECo GitHub pages](#).

Limitations and future work

We briefly list a few directions of interest for future work.

- GECo currently uses a uniform mesh. However, in axisymmetry (unlike spherical symmetry) the solution is not uniquely defined outside the support of the matter, and asymptotically flat boundary conditions must be applied sufficiently far from the matter. An adaptive mesh refinement algorithm was developed and used in ([Ames et al., 2019](#)) to investigate properties of extreme rotating toroidal solutions. It remains however to integrate such an adaptive mesh refinement scheme into the core of GECo.
- Currently the particles only interact via the gravitational field generated by the particle distribution. An exciting area at the frontier of astrophysics currently is the study of accretion disks, where both central black holes and electromagnetic fields play important roles. To lay groundwork for this area in fundamental relativity, it is thus highly desirable to extend GECo to the Einstein-Vlasov-Maxwell system and allow the inclusion of central black holes.
- While multi-species solutions can be generated in which the different species follow different distribution ansatzes, the particle properties are otherwise taken to be the same. Astrophysical systems however often consist of particle-like entities with very different properties (such as stars and dust). We thus propose to allow different particle species to have different particle properties such as mass and charge.

References

- Ames, E., Andréasson, H., & Logg, A. (2016). On axisymmetric and stationary solutions of the self-gravitating Vlasov system. *Class. Quantum Grav.*, 33(15), 155008. <https://doi.org/10.1088/0264-9381/33/15/155008>
- Ames, E., Andréasson, H., & Logg, A. (2019). Cosmic string and black hole limits of toroidal Vlasov bodies in general relativity. *Physical Review D*, 99(2), 024012. <https://doi.org/10.1103/PhysRevD.99.024012>
- Andréasson, H. (2011). The Einstein-Vlasov System/Kinetic Theory. *Living Reviews in Relativity*, 14. <https://doi.org/10.12942/lrr-2011-4>
- Binney, J., & Tremaine, S. (2008). *Galactic Dynamics: Second Edition*. Princeton University Press. ISBN: 0691130264
- Logg, A., Mardal, K.-A., & Wells, G. (Eds.). (2012). *Automated Solution of Differential Equations by the Finite Element Method* (Vol. 84). Springer Berlin Heidelberg. <https://doi.org/10.1007/978-3-642-23099-8>
- Walker, H. F., & Ni, P. (2011). Anderson acceleration for fixed-point iterations. *SIAM Journal of Numerical Analysis*, 49, 1715. <https://doi.org/10.1137/10078356X>